

## Fuji Discrete Package IGBT

## ■ Outline Drawing

### ■ Features

- Square RBSOA
- Low Saturation Voltage
- Less Total Power Dissipation
- Minimized Internal Stray Inductance

### ■ Applications

- High Power Switching
- A.C. Motor Controls
- D.C. Motor Controls
- Uninterruptible Power Supply

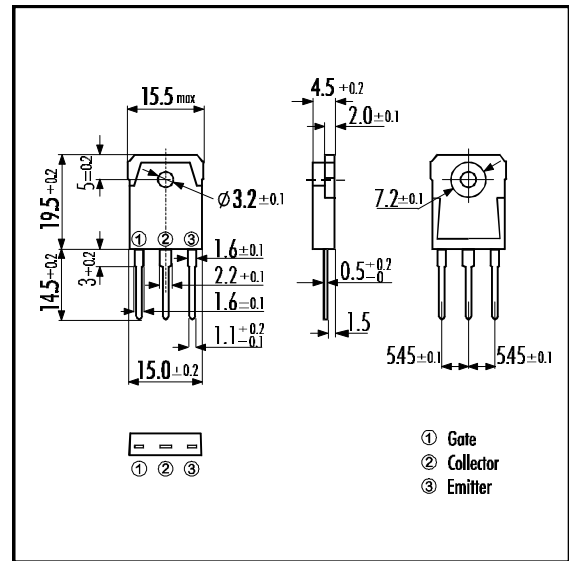

## ■ Maximum Ratings and Characteristics

### • Absolute Maximum Ratings ( $T_c=25^\circ\text{C}$ )

Items	Symbols	Ratings	Units
Collector-Emitter Voltage	$V_{CES}$	1200	V
Gate -Emitter Voltage	$V_{GES}$	$\pm 20$	V
Collector Current	DC $T_c=25^\circ\text{C}$	$I_{C25}$	16
	DC $T_c=100^\circ\text{C}$	$I_{C100}$	10
	1ms $T_c=25^\circ\text{C}$	$I_{CPULSE}$	48
IGBT Max. Power Dissipation	$P_C$	135	W
FWD Max. Power Dissipation	$P_C$	85	W
Operating Temperature	$T_j$	+150	$^\circ\text{C}$
Storage Temperature	$T_{stg}$	-40 ~ +150	$^\circ\text{C}$
Mounting Screw Torque		50	Nm

## ■ Equivalent Circuit

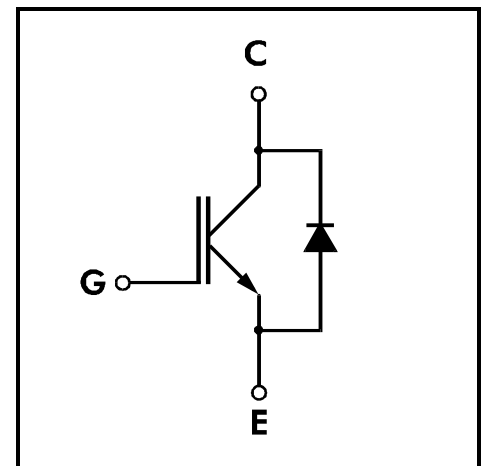

### • Electrical Characteristics ( at $T_j=25^\circ\text{C}$ )

Items	Symbols	Test Conditions	Min.	Typ.	Max.	Units	
Zero Gate Voltage Collector Current	$I_{CES}$	$V_{GE}=0V$ $V_{CE}=1200V$			1.0	mA	
Gate-Emitter Leakage Current	$I_{GES}$	$V_{CE}=0V$ $V_{GE}=\pm 20V$			20	$\mu\text{A}$	
Gate-Emitter Threshold Voltage	$V_{GE(th)}$	$V_{GE}=20V$ $I_C=10\text{mA}$	5.5		8.5	V	
Collector-Emitter Saturation Voltage	$V_{CE(sat)}$	$V_{GE}=15V$ $I_C=10A$			3.5	V	
Input capacitance	$C_{ies}$	$V_{GE}=0V$		1200		pF	
Output capacitance	$C_{oes}$	$V_{CE}=10V$		250			
Reverse Transfer capacitance	$C_{res}$	$f=1\text{MHz}$		80			
Switching Time	Turn-on Time	$t_{ON}$	$V_{CC}=600V$			1.2	$\mu\text{s}$
		$t_r$	$I_C=10A$			0.6	
		$t_{OFF}$	$V_{GE}=\pm 15V$			1.5	
		$t_f$	$R_G=160\Omega$			0.5	
	Turn-off Time	$t_{ON}$	$V_{CC}=600V$		0.16		$\mu\text{s}$
		$t_r$	$I_C=10A$		0.11		
		$t_{OFF}$	$V_{GE}=\pm 15V$		0.30		
		$t_f$	$R_G=16\Omega$			0.5	
Diode Forward On-Voltage	$V_F$	$I_F=10A$ $V_{GE}=0V$			3.0	V	
Reverse Recovery Time	$t_{rr}$	$I_F=10A$ , $V_{GE}=-10V$ , $di/dt=100A/\mu\text{s}$			350	ns	

### • Thermal Characteristics

Items	Symbols	Test Conditions	Min.	Typ.	Max.	Units
Thermal Resistance	$R_{th(j-c)}$	IGBT			0.92	$^\circ\text{C/W}$
	$R_{th(j-e)}$	Diode			1.47	

Collector Current vs. Collector-Emittor Voltage

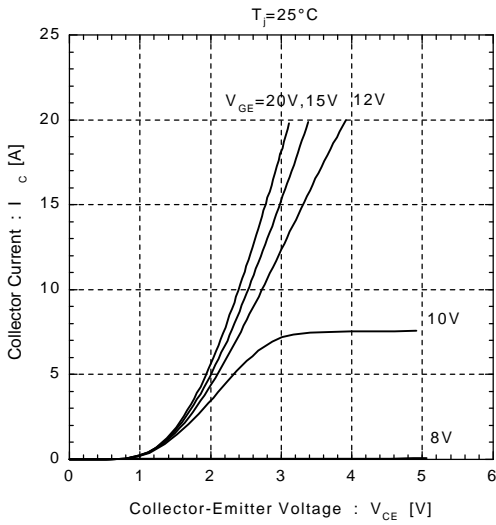

Collector Current vs. Collector-Emittor Voltage

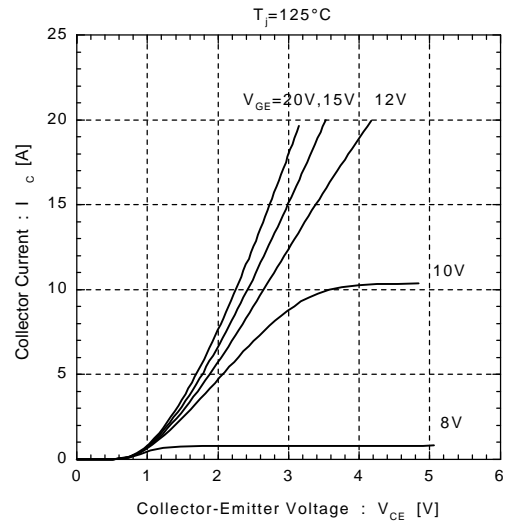

Collector-Emittor Voltage vs. Gate-Emittor Voltage

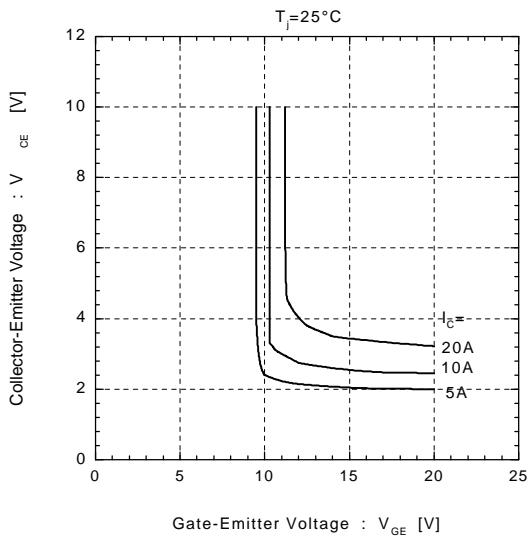

Collector-Emittor Voltage vs. Gate-Emittor Voltage

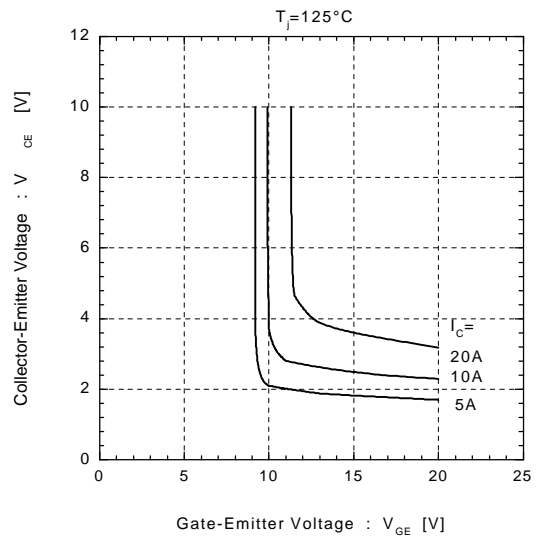

Switching Time vs. Collector Current

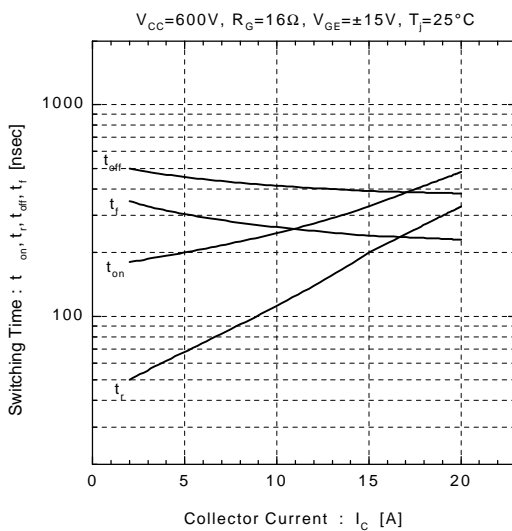

Switching Time vs. Collector Current

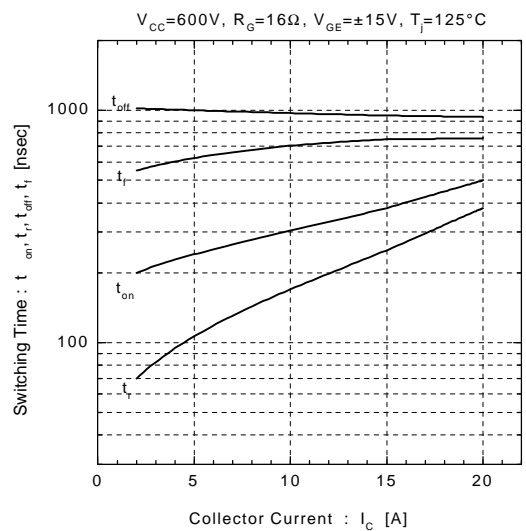

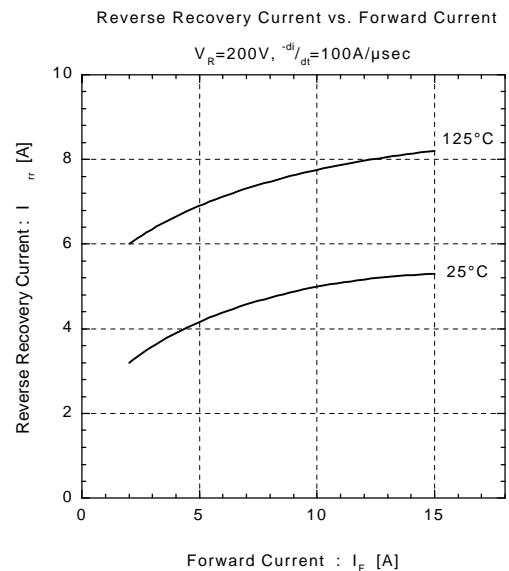
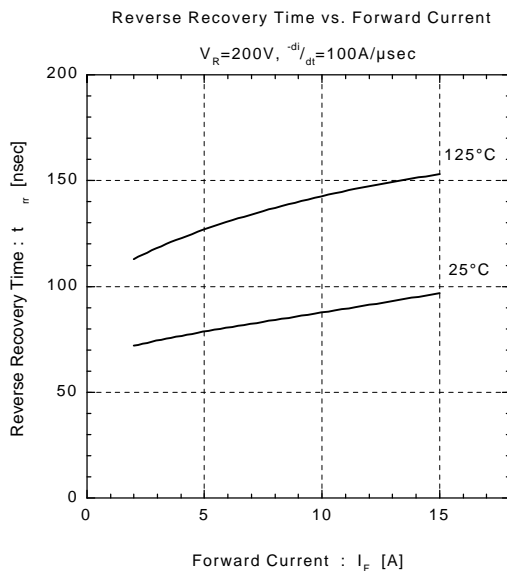
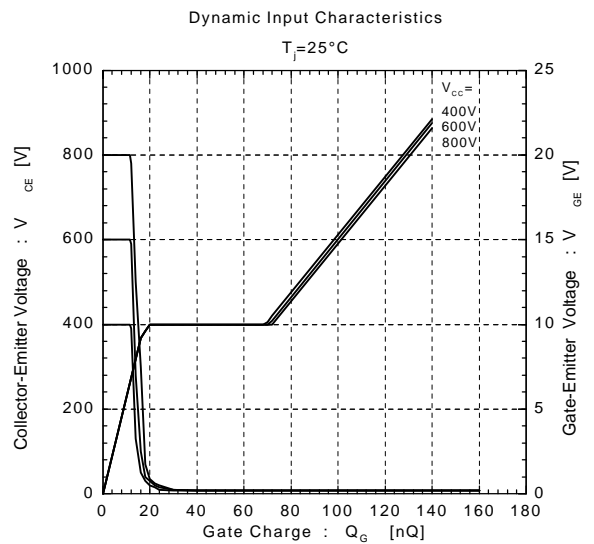
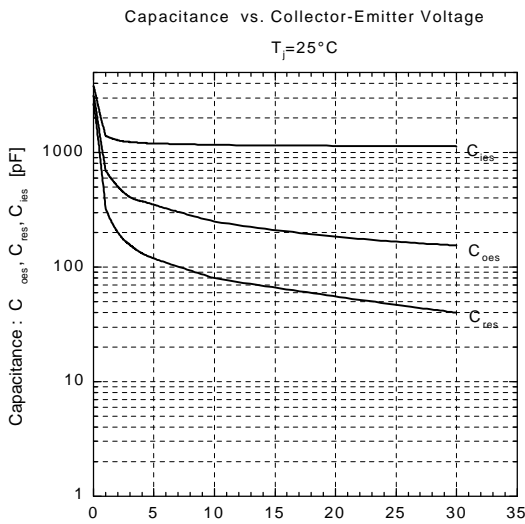
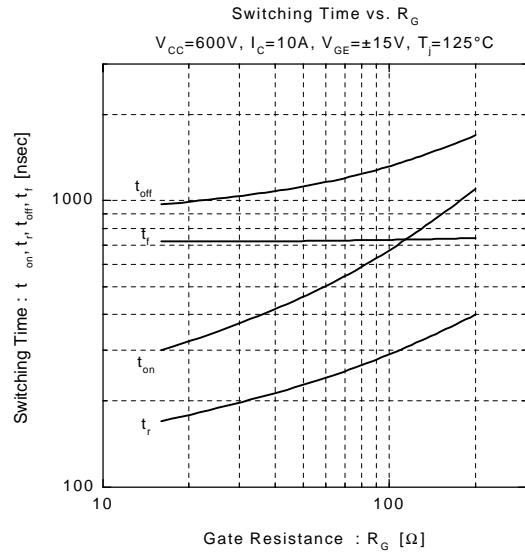
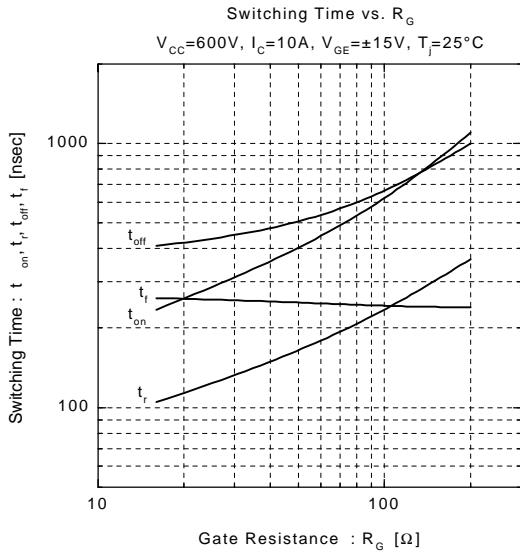

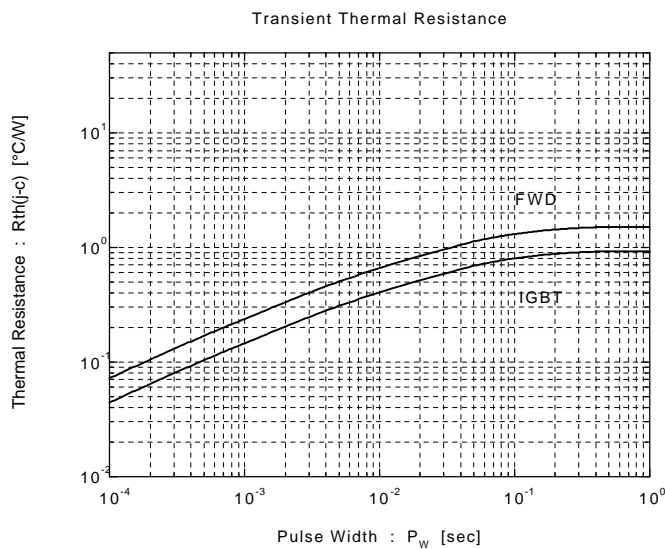
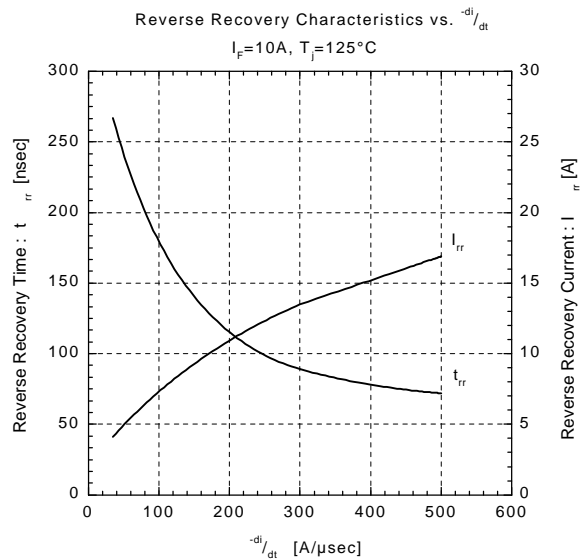
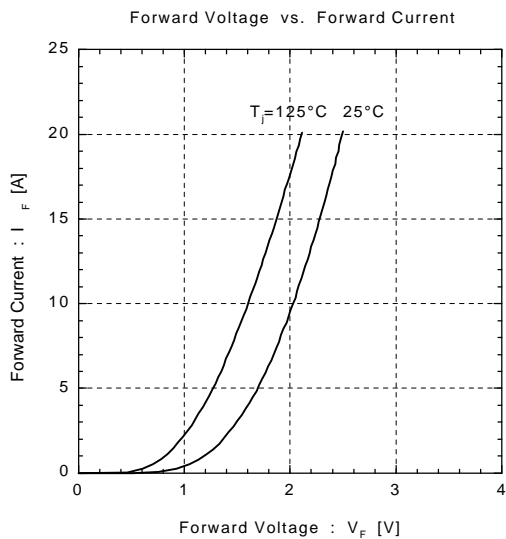
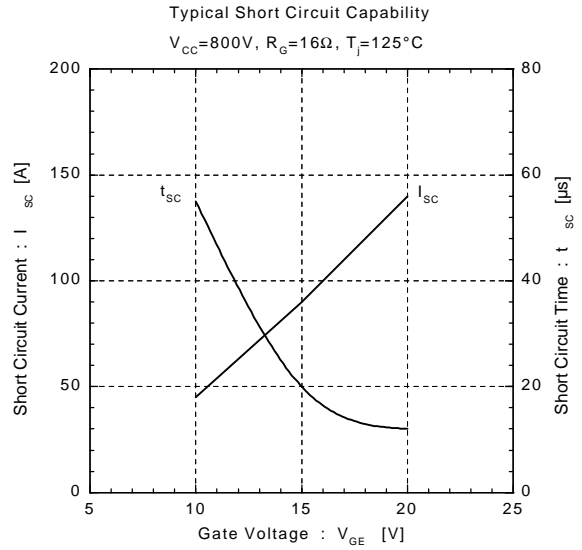
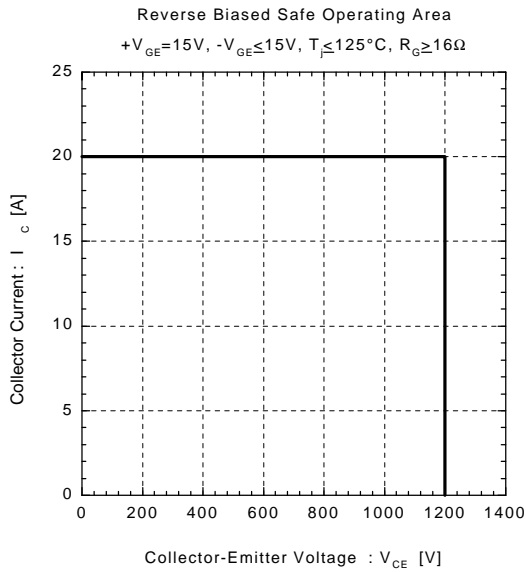

### Switching losses ( $E_{on}$ , $E_{off}$ vs. $I_c$ )

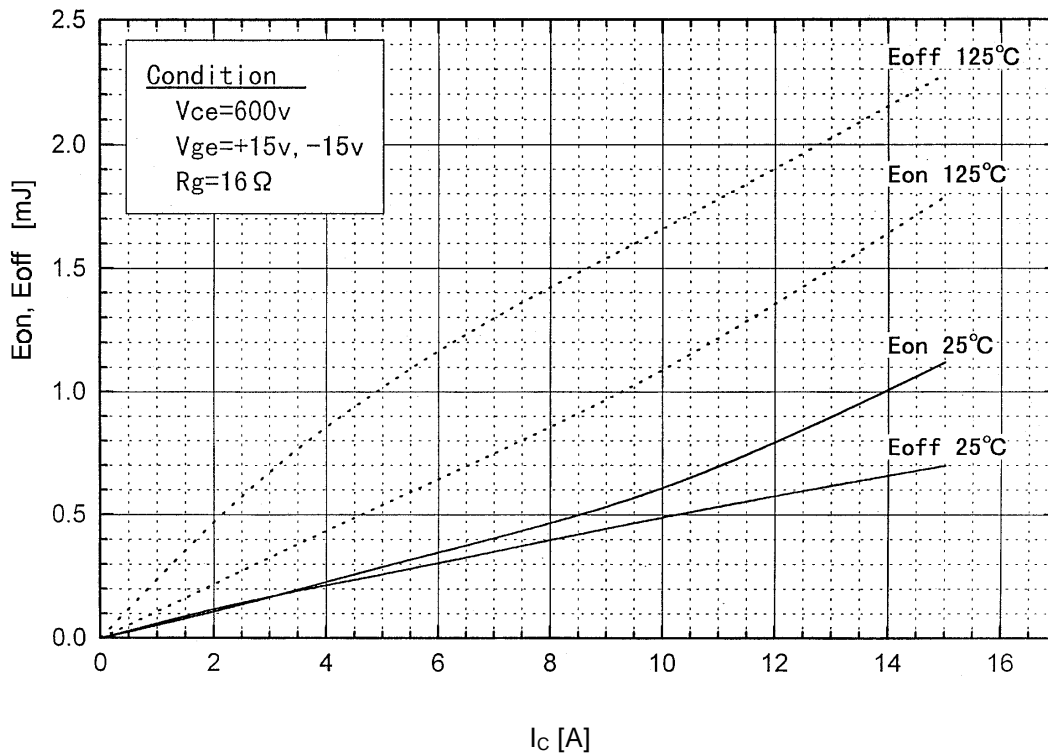

### Test Circuit

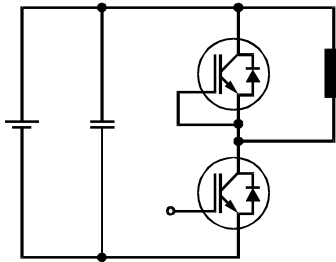

### Switching waveforms

